

**4-Person Floor Mount
Stainless Steel Wash Station**

Model	Flow-Rate
58FFL	Standard 2.0 GPM
58FFL-0.5	Low-Flow 0.5 GPM

Product Specifications

Constructed from welded #16 gauge type 304 stainless steel. The front, bottom and back are formed from a single sheet with a rolled rim on front and sides. Exposed surfaces have a blended uniform satin finish.

Outside Dimensions	80" x 20" x 45" High
Inside Bowl Size	77" x 16-1/2" x 8" Deep
Back Splash Height	10"
Faucet Mounting Center	8"
Water Activation	Manual Faucet with 4" Handles
Flow Rate	2 GPM
Inlet Connections	1/2" Male NPT
Drain Opening	2"
Finish	Satin
Strainer	1-1/2" Dia. Duo Basket Strainer



Includes

- (1) Floor mount wash station
- (1) Leg assembly set
- (6) Washers and nuts for connection sink to leg assembly set
- (4) 8" on center faucet
- (4) Faucet mounting kit
- (2) Strainer assembly with basket

Product Compliance

NSF/ANSI 2 Food Equipment
NSF/ANSI 61, Section 9
ASME A112.18.1/CSA B125



Part: _____ Quantity: _____

Project: _____

Contact: _____

Date: _____

Approval: _____

Notes:



WARNING: Equipment that include faucets on this page may contain a chemical known to the State of California to cause cancer, birth defects or other reproductive harm.

4-Person Floor Mount Stainless Steel Wash Station
Models 58FFL and 58FFL-0.5

■ **Top**

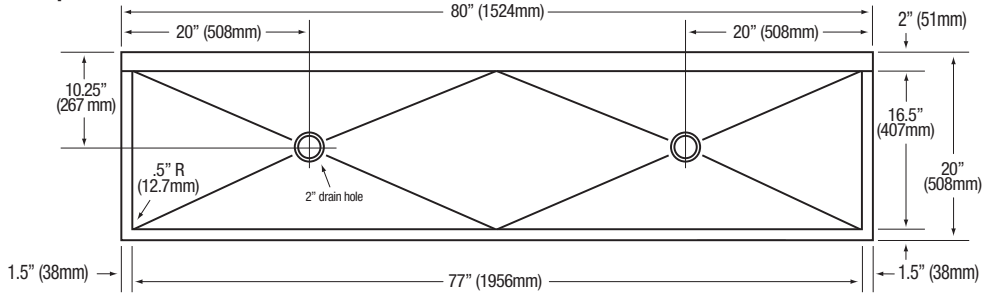

■ **Front**

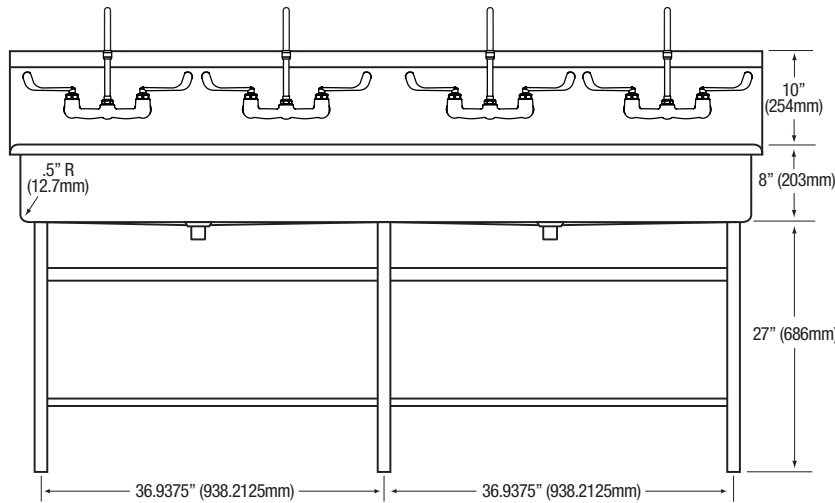

■ **Side**

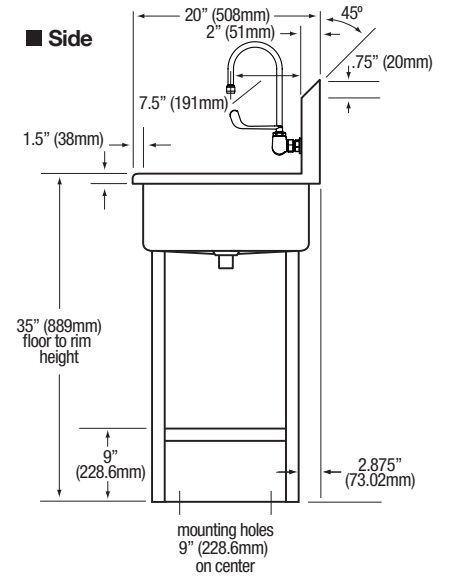

■ **Hole Configurations**

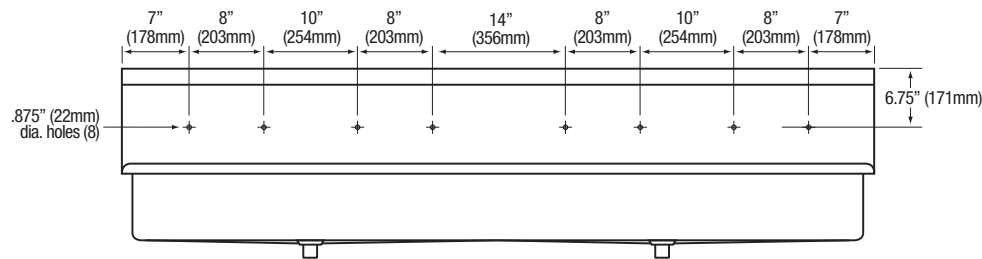

■ **Floor Mounting Detail**

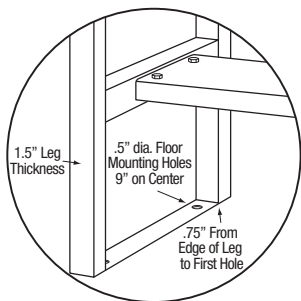

■ **Supply Line Detail**

