

SANI-LAV[®] COLUMBIA PRODUCTS

Operating Manual for Floor Mount Stainless Steel Sink Models 503FL and 503FL-0.5

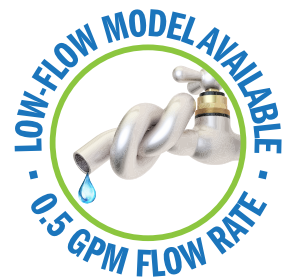

Columbia does not recommend use with harsh chemicals.

Product Compliance

NSF/ANSI 2 Food Equipment, NSF/ANSI 61, Section 9, ASME A112.18.1/CSA B125.1



Parts List

- (1) Sink bowl
- (1) Pedestal base
- (6) Nuts and washers to attach bowl to pedestal base
- (1) 8" on center faucet
- (1) Faucet mounting kit
- (1) Strainer assembly with basket

Tools Required

- Tape measure
- Adjustable wrench
- Drill motor and drill bits
- Pipe wrench
- Level
- Safety glasses
- Screw drivers: phillips and standard
- Pencil
- Socket wrench

Installation Instructions

Step 1

1. Attach bowl to pedestal base by slipping bolts on bowl through openings on pedestal base as shown in illustration A.
2. Tighten the 6 nuts to the threaded bolts under bowl. Do not over-tighten. There are 6 bolts that will securely hold the bowl in place.



Illustration A

Step 2

1. Place the sink at the desired location.
2. Mark the floor where the four holes are at the pedestal base as shown in illustration B.
3. Drill holes as required for mounting hardware. (Hardware not included)

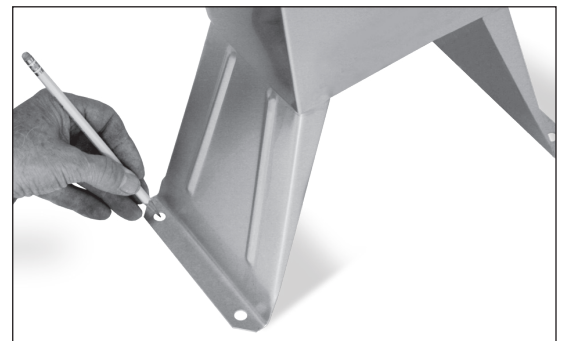

Illustration B

Step 3

1. Install strainer assembly using plumbers putty to seal the strainer to sink.
2. Install faucet assembly to the sink back-splash.
3. Install hot and cold water lines to the back of the faucet. (not provided)

Step 4

1. Mount pedestal sink to the floor.
2. Connect waste line or drain pipe to strainer assembly. (not provided)
3. Connect hot and cold water supply lines to the water sources. (not provided)

Step 5

1. Turn water on.
2. Remove aerator from the spout and flush water system.
3. Check connections for leaks.
4. Replace aerator onto the spout.

Go to columbiasinks.com for more information on replacement parts and installation videos.

Trouble Shooting Guide

Problem	Possible Cause	To Diagnose	Remedy
Water drips from the spout or from under the lever.	1. Seat washer is worn 2. Seat is worn 3. O-rings are worn	Shut cold water source off. See if water still leaks from the spout. If leaks continues repair hot side if not repair cold side.	Recommend installing hot or cold faucet repair kit.

Notice for California Consumers

WARNING: This product can expose you to chemicals including Chromium (hexavalent compounds), Lead, and Phthalates (DEHP) which are known to the State of California to cause cancer and birth defects or other reproductive harm. For more information go to www.P65Warnings.ca.gov.

NOTE: Lead content originates from Brass components in valves and faucets and is certified under NSF/ANSI 372 as containing less than 0.25% lead in wetted surfaces.

■ Top

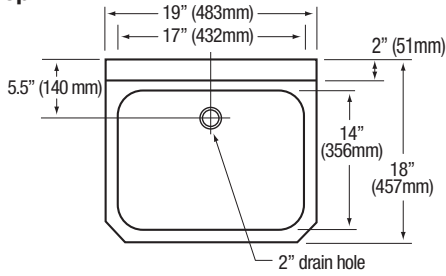

■ Front

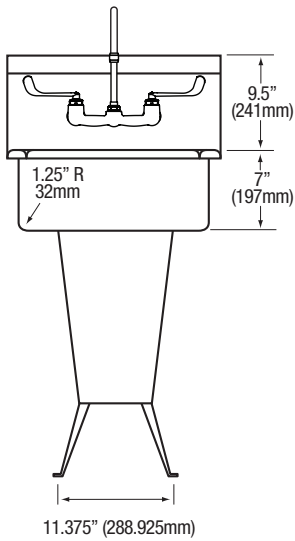

■ Side

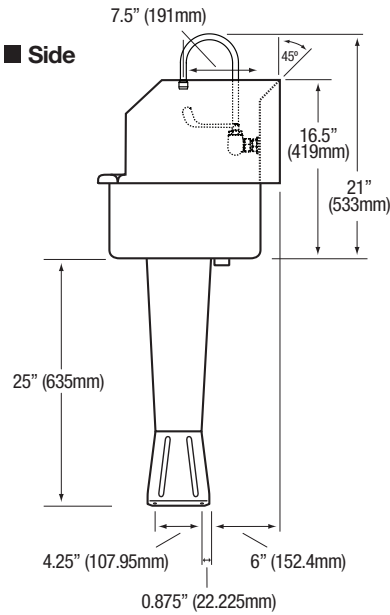

■ Hole Configurations

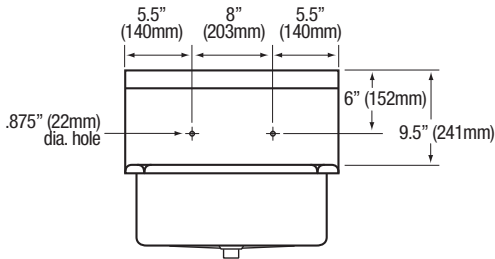

■ Floor Mounting Detail

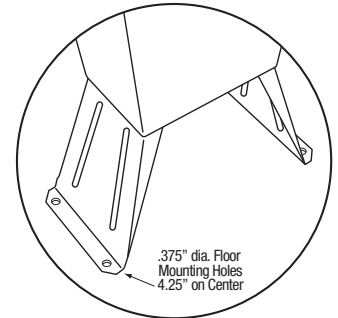

■ Supply Line Detail

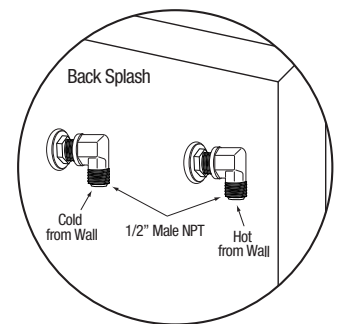

Replacement Parts

Part No.	Description	Quantity
1 204SP	10" Gooseneck Swivel Spout	1
2 1002	Aerator 55/64 - 27 Thread Size Standard 2.0 GPM Flow Rate	1
3 1003	Aerator 55/64 - 27 Thread Size Low-flow 0.5 GPM Flow Rate	1
4 211C	4" Wrist Handle Replacement Kit	
A	Hot Side Handle, Screw and Color Coded Washer	1
B	Cold Side Handle, Screw and Color Coded Washer	1
5 204RK	Faucet Valve Repair Kit	
A	Hot Side Valve Assembly	1
B	Cold Side Valve Assembly	1
6 1009	Faucet Mounting Kit Brass Elbow, Nipple, Nut and Washer	1
7 24FL	Female Wall Flange Hot or Cold Side Assembly	1

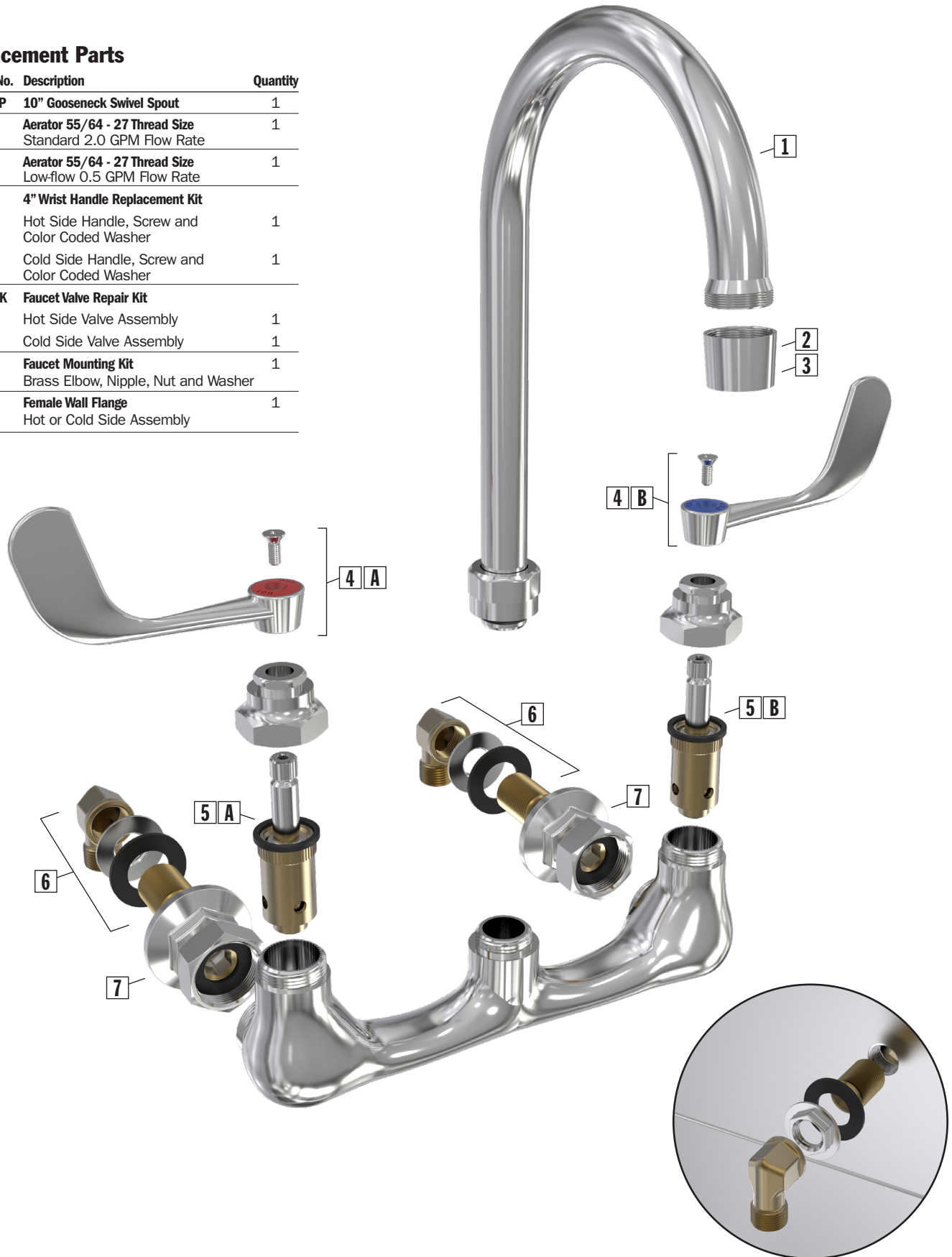

Care and Maintenance

Regular cleaning will preserve the appearance and integrity of the surface. Stainless steel can easily be cleaned and kept stain-free using various methods.

Recommendations:

- Clean with an abrasive cleaner like, Bon-Ami or Zud weekly or bi-weekly. Always scrub in the direction of the grain or polish lines. Another option is to use Baking soda. Make sure to rinse well and dry. Illustration A
- Most soaps and detergents contain chlorides, we recommend rinsing the stainless-steel sink with hot water after use, to prevent corrosion. Illustration B
- Regularly dry your sink to prevent water and surface rust marks. Illustration C
- Do not leave salt in the sink or near a saltwater environment.
- Use a quality stainless steel cleaner and follow cleaner instructions. Wipe along the grain (NOT against). Illustration D

Things to Avoid:

- Avoid harsh abrasive cleaners and corrosive chemicals.
- Avoid abrasive scouring pads, carbon steel brushes and steel wool for cleaning as iron particles left behind can lead to rust.
- Avoid the use of oily rags or greasy cloths when wiping the surface. To avoid water spots, wipe dry after use.

Additional Tips:

- Regularly drying your sink works wonders to prevent water and surface rust marks.
- Wear rubber gloves when working with cleaners to protect your hands.
- Never mix cleaners. Some products react to create dangerous gases.
- There are thousands of blended or compound cleaners on the market. Users are advised to contact suppliers of solvents for information on their applications on stainless steel.
- DO NOT USE SOLVENTS in closed spaces or while smoking.
- Note: Columbia does not recommend use with harsh chemicals.



Illustration A



Illustration B



Illustration C

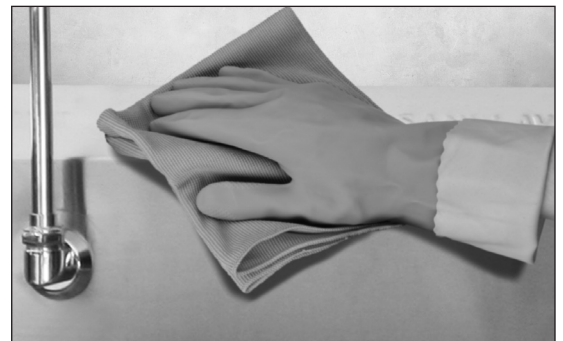

Illustration D